

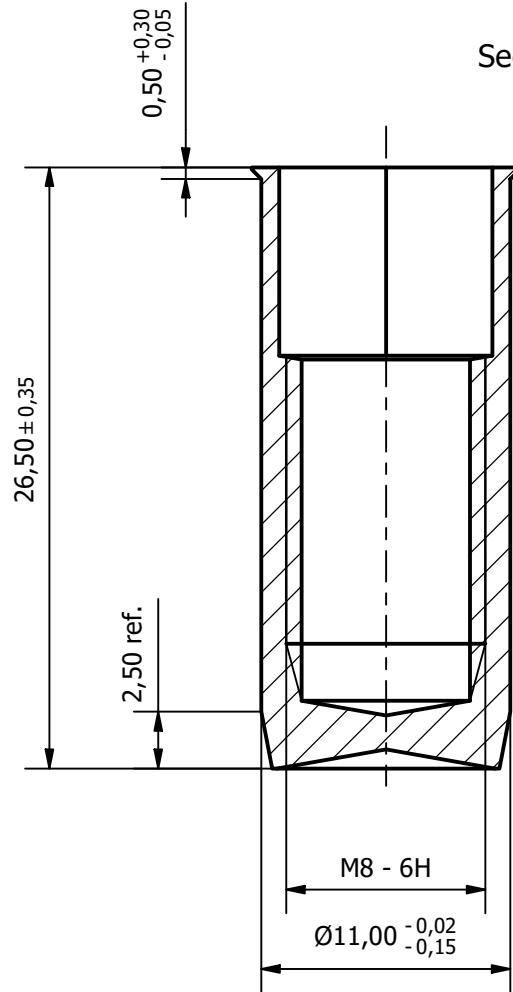

This drawing is property of Dejongd. No reproduction without written permission!

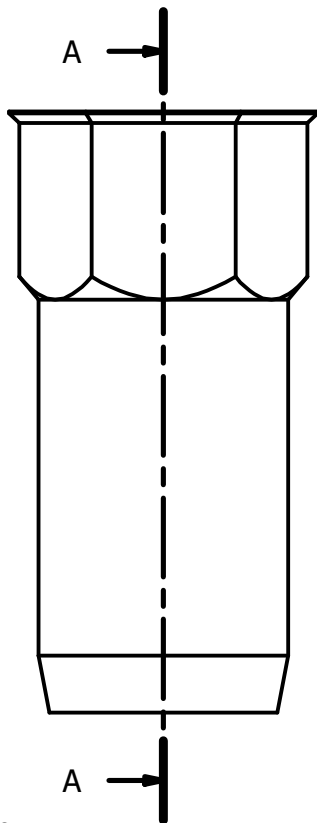

Hole size

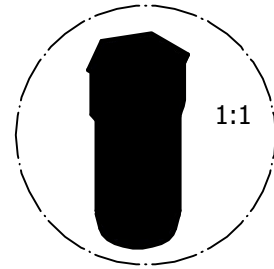
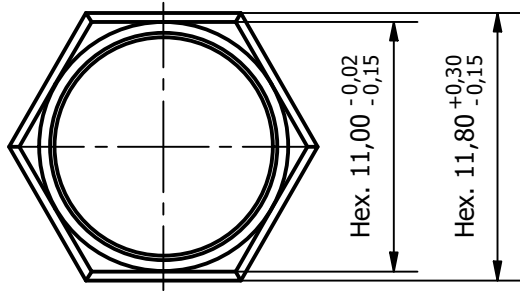
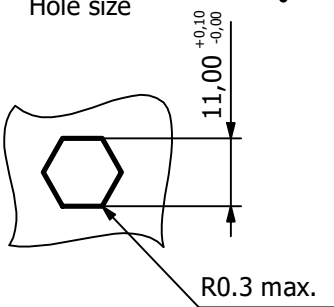

GRIP 3,0 - 5,5 mm

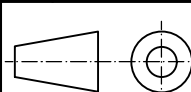
REV	DESCRIPTION			STATUS	APPROVED	DATE
A				For Review		04/09/2019
Finish / Coating : Polished				 Tubtara [®] BLIND RIVET NUTS A BRAND BY DEJOND NV		
	Name	Date	Material : Stainless steel 304 Cu			
Designed by	Simon VL	4/09/2019	Sp. Treat. :	Art. Nr. : 548340		
A4		Scale 3 : 1	Art. Nr. Cust. :	Draw. Nr. : 304 M8 HUKX 55		
			Weight : ± 9,8 g			