

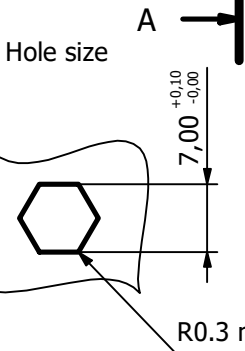

This drawing is property of Dejongd. No reproduction without written permission!

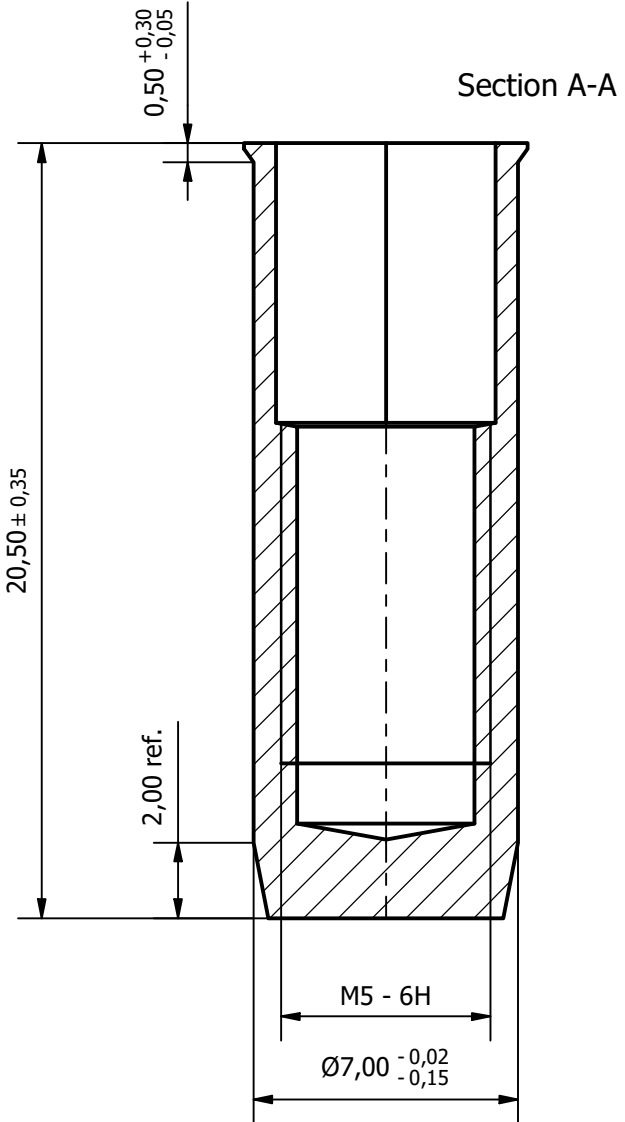
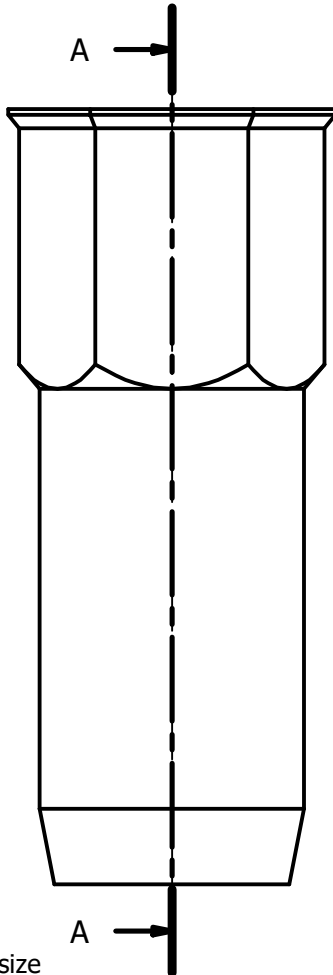
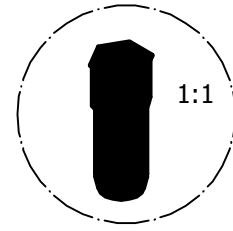
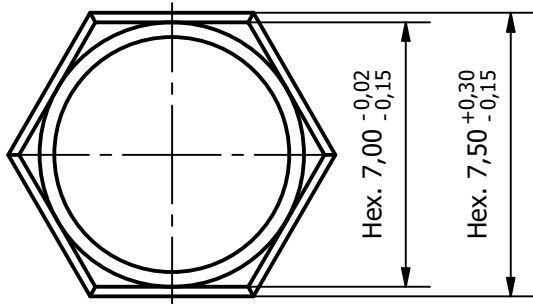
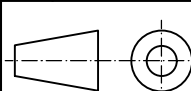

GRIP 3,0 - 5,0 mm

REV	DESCRIPTION		STATUS	APPROVED	DATE
A			Released	Janm	01/12/2019
Finish / Coating : Polished			 <b>Tubtara</b> <sup>®</sup> BLIND RIVET NUTS <small>A BRAND BY DEJOND NV</small>		
	Name	Date			
Designed by	Douwe W.	29/11/2019	Sp. Treat. :	Art. Nr. : 545640	
A4		Scale 5 : 1	Art. Nr. Cust. :	Draw. Nr. :	
			Weight : ± 3,2 g	Customer Draw.	304 M5 HUKX 50